

**SM-2008FFN-L**  
**Fan Coil Thermostat**

For 2-pipe and 4-pipe Fan Coil Units

**Features**

- Manual or automatic 3-stage fan control
- On/Off Heating/Cooling valve control
- Blue backlight
- Recessed Mounting
- Lower/Upper Limiting

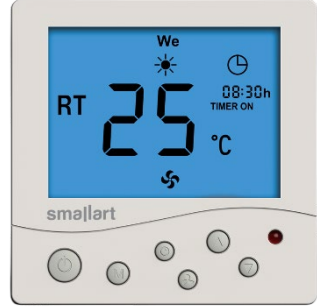

**Application**

SM-2008FFN-L series Fan Coil Thermostat is used in buildings, rooms or spaces. The thermostat is designed and manufactured to be used in 2-pipe or 4-pipe systems. SM-2008FFN-L device has five relay outputs that can be used as on/off contacts. The thermostat controls the fan coil unit based on the room sensor and internal temperature sensor.

**Notes on Usage**

Please read the document carefully. SM-2008FFN-L thermostat is designed and manufactured in accordance with the latest technological developments and safety rules. Safety warnings must be observed to prevent injury and material damage.

**Security Advice-Caution**

Installation, maintenance and repair of the device must be done by authorized personnel. The thermostat's power supply is 220 V AC and it has no internal fuse. For external protection, a max C type 10A fuse must be used. The power must be cut off before removing the front panel.



**About Product**

Product Code	Description	Power
SM-2008FFN-L	3 pcs Digital Outputs (Relay) Fan Control 2 pcs Digital Outputs (Relay) Valve Control	220 VAC

**Technical Specifications**

Power Supply	220V AC $\pm 10\%$ , 50/60Hz
Power Consumption	< 2.0W
Electrical Connection	Terminal Connectors
Relay Rating	1A
Temperature Accuracy	$\pm 1^\circ\text{C}$

Temperature Control Accuracy	±1°C
Outputs	5 pcs Digital Output (5A Relay)
Maximum Humidity	%5~90
Valve Control	On/Off
Storage Temperature	-10~60 °C
Operating Temperature	0~45 °C
Grade of Protection	IP20
Dimensions	86 x 86 x 13 mm
Mounting	Recessed Mounting
Temperature Range	5~35°C adjustable

### Mounting Location

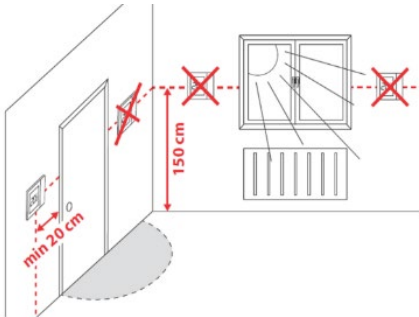

Mount the room thermostat on the cable conduit. Do not mount in niches or bookcases, behind curtains, above or near heat sources. Install at a height of about 1.5 meters from the floor. Devices must be mounted on clean, dry indoor place without direct airflow from a heating/cooling device. Do not expose to dripping or splashing.

**CAUTION: Disconnected the power supply before removing the front cover. Wiring, protection, and earthing should be done in accordance with the direction.**



**Mounting Instructions**

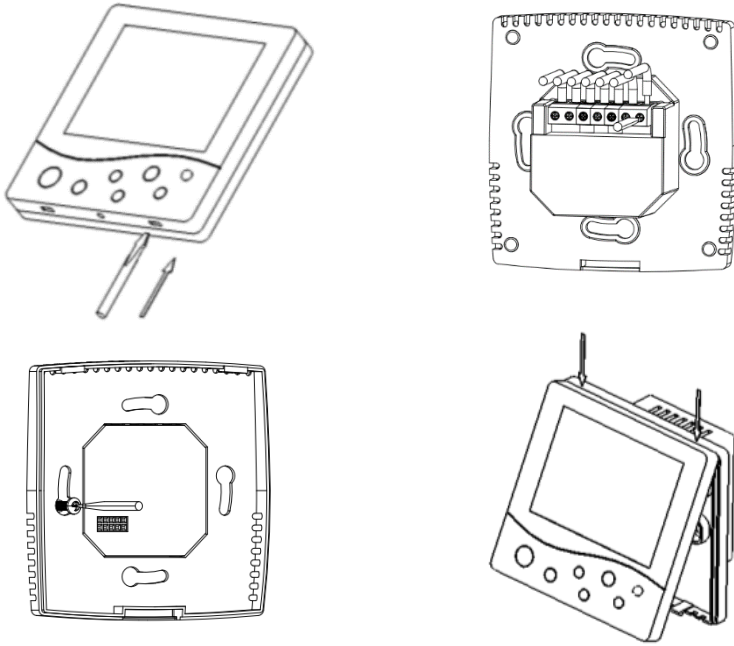

Please follow below instructions during mounting.

**Step 1:** Take the thermostat and the document out of the box. Open the tabs at the bottom with a 3.5mm screwdriver.

**Step 2:** Connect the cables according to the wiring diagram below.

**Step 3:** Mount the back cover on the wall.

**Step 4:** Attach Connect the front plate to the back plate. Make sure that the pins on the front plate are fully inserted into the back plate. Push the front of the case until you hear a click.

**Step 5:** Refer to the pictures after installation.

**Step 6:** Power on the thermostat to work.

**Important Note:** It is recommended to use the screws included in the product box. Otherwise, there could be fitting problems during the mounting.

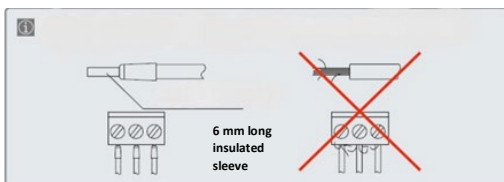

**Caution!** The ends of the connecting wires must be protected against delamination using insulated sleeves as shown in the figure.

**Wiring Diagram**

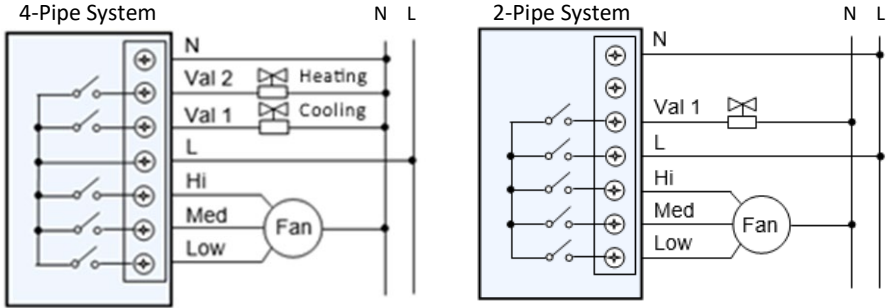

**Ekran ve İşleyiş Display and Operations**

- **On/Off:** Press power button to switch on and off thermostat.
- **Temperature Setting** Press the “□” button to decrease the temperature and the “□” button to increase the temperature.
- **Heating:** Press “☀” button until “M” sign appears on the screen. Cooling mode becomes active 5 seconds after it is selected.
- **Auto (Cool/Heat):** Press “M” button until “☁” sign appears on the screen. Automatic mode is activated 5 seconds after it is selected. If the room temperature is 1°C or more above the set value, the controller will automatically switch to Cooling mode; If the room temperature is 1°C or more below the set value, the controller will automatically switch to heating mode.
- **Fan Speed Setting:** Press “🌀” button to change the fan speed “🌀 (High), 🌀 (Medium), 🌀 (Low), 🌀 (Auto)”. When (Auto) is selected, the fan speed is adjusted automatically. If the difference between the room temperature and the set value is 1°C, Low Speed

**Sensor Calibration:**

Turn off the controller and press and hold the “M” and “☺” keys simultaneously for 3 seconds. “XX °C” appears on the display. Set the correct temperature by pressing the “▲” or “▼” keys. Changes become active automatically after 6 seconds or when the controller is turned off.

**Low Temperature (Freeze) Protection:**

When the room temperature drops by 5°C when the controller is turned off, the controller will automatically turn on in heating mode. The fan runs at high speed and the heating valve opens. When the room temperature rises by 7°C, the fan and the heating valve are automatically turned off.



**LOW TEMPERATURE PROTECTION SETTING:** Turn off the controller and press and hold the “M” key for 3 seconds. “00” or “01” is displayed on the screen. By pressing the “☐” or “☐” keys, the desired state is set.

“00” undertemperature protection inactive

“01” undertemperature protection active.

Default is “00”

### Configuration Menu Parameters

- Press and hold the power button “” for 10 seconds to enter the configuration menu.
- You will see the parameter number and value on the screen (For example “1 04”).
- “▲” and “▼” You can change the setting value with the keys.
- Move to the next parameter by pressing the “M” key and change the parameter value by repeating the above steps.
- Press the “” button or wait about 1 minute to exit the configuration menu.

No.	Parameter Name	Parameter Description	Default
P1	Fan Coil System Selection	03= 2-pipe	X
		04= 4-pipe	
P2	Fan Control Operation	DA= Fan is always on as long as the controller is on. DB= The fan only works if there is a heating/cooling request.	X
P3	Power on status in case of power failure	01= System On (in any case)	X
		02= System Off (in any case)	
		03= System in Last Position	
P4	Valve Type Selection	00= Val1 and Val2 Normally Open	X
		01= Val1 Normally Closed, Val2 Normally Open	
		02= Val1 Normally Open, Val2 Normally Closed	
		03= Val1 and Val2 Normally Closed	
P5	Mode Control Selection	00= Manuel	X
		01= Automatic (Only in 4-pipe system)	
P6	Dead Zone (Heating-Cooling)	01-05= Active in Auto mode for 4-pipe systems	01 °C
P7	Heating System	00= Fan Coil (Fan works normally in heating mode)	X
		01= Radiator (Fan does not work in heating mode)	
P8	Setpoint Low Limit	05-22= Adjust Between 5 °C...22 °C	05 °C
P9	Setpoint High Limit	23-35= Adjust Between 23 °C...35 °C	35 °C

### Table Descriptions

**P1- Selectable System Type:** It is used to select the unit control type as 2 or 4 pipes.

**P2- Fan Control:** This parameter determines the operating state of the fan after the room temperature reaches the set value

**P3- Power on status in case of power failure:** This parameter determines in which state the device will turn on when the power is turned off and then on again. There are three states:

- 1: Automatically open the system.
- 2: Keep system off.
- 3: Keep the original state of the system before the power failure.

**P4- Valve Type Selection:** This parameter determines that each valve is normally closed and normally open for 4 different states.

**P5- Mode Control Selection:** It can manually select the heating or cooling mode. When the automatic selection is made, if the set value is entered above the ambient temperature, the fan coil is activated and tries to heat the environment. On the contrary, it tries to cool the environment.

**P6- Dead Zone:** This parameter determines the zone where the device will not heat or cool. No heating or cooling takes place until the difference between the setpoint and the room temperature exceeds this zone.

**P7- Heating system:** Determines whether the fan works in heating mode.

**P8&P9- Temperature Limitation:** The minimum and maximum temperature set values that can be entered via the thermostat are set

**Dimensions (mm):**

